

TRU-CLOSE HEAVY DUTY HINGES ON PED GATE
1:4

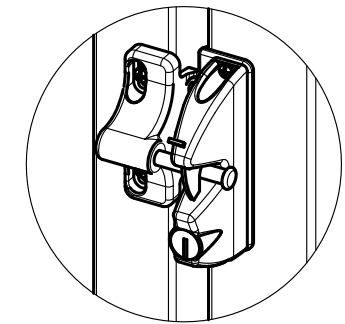

LOKKLATCH ON PED GATE
1:4

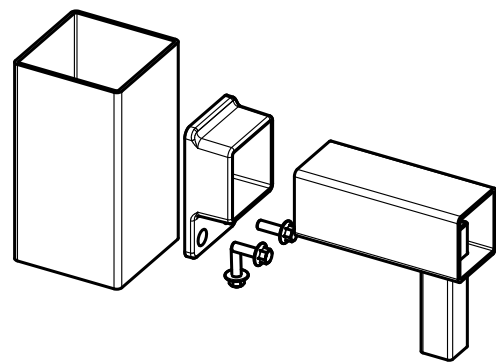

FIXED PANEL TO POST DETAIL
1:4

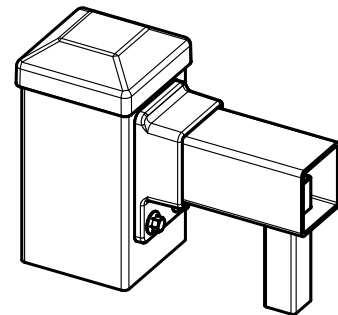

FIXED PANEL TO POST DETAIL
1:4

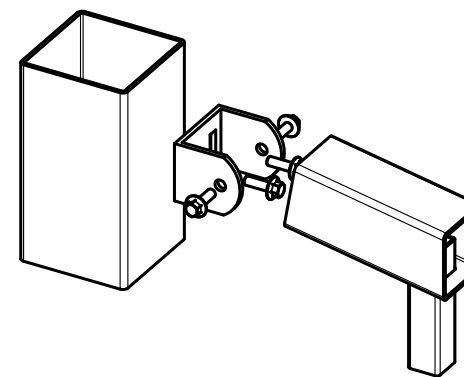

RAKING PANEL TO POST DETAIL
1:4

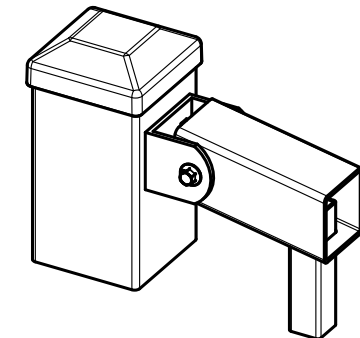

RAKING PANEL TO POST DETAIL
1:4

PANEL CODE	DESCRIPTION	BRACKET CODE	HEIGHT	WIDTH	PANEL RAKE	HORIZONTALS	VERTICALS	TUBE SPACINGS
UFPRE10	PREMIER FENCE PANEL	HBKT40	1000	2400	N/A	40X40X2 SHS	19X19X1.2 SHS	91 (110 CENTRES)
UFPRER10	PREMIER RAKING FENCE PANEL	HBKTR40	1000	2400	22 DEGREES	40X40X2 SHS	19X19X1.2 SHS	91 (110 CENTRES)
SGPR/1009	PREMIER PEDESTRIAN GATE	N/A	1000	960	N/A	40X40X2 SHS	19X19X1.2 SHS	91 (110 CENTRES)



SIZE:	A3	SCALE:	1:25
DRAWING NO:	PRE10 - SS	REVISION:	01
DATE ISSUED:	2023-02-22	SHEET:	1 OF 2

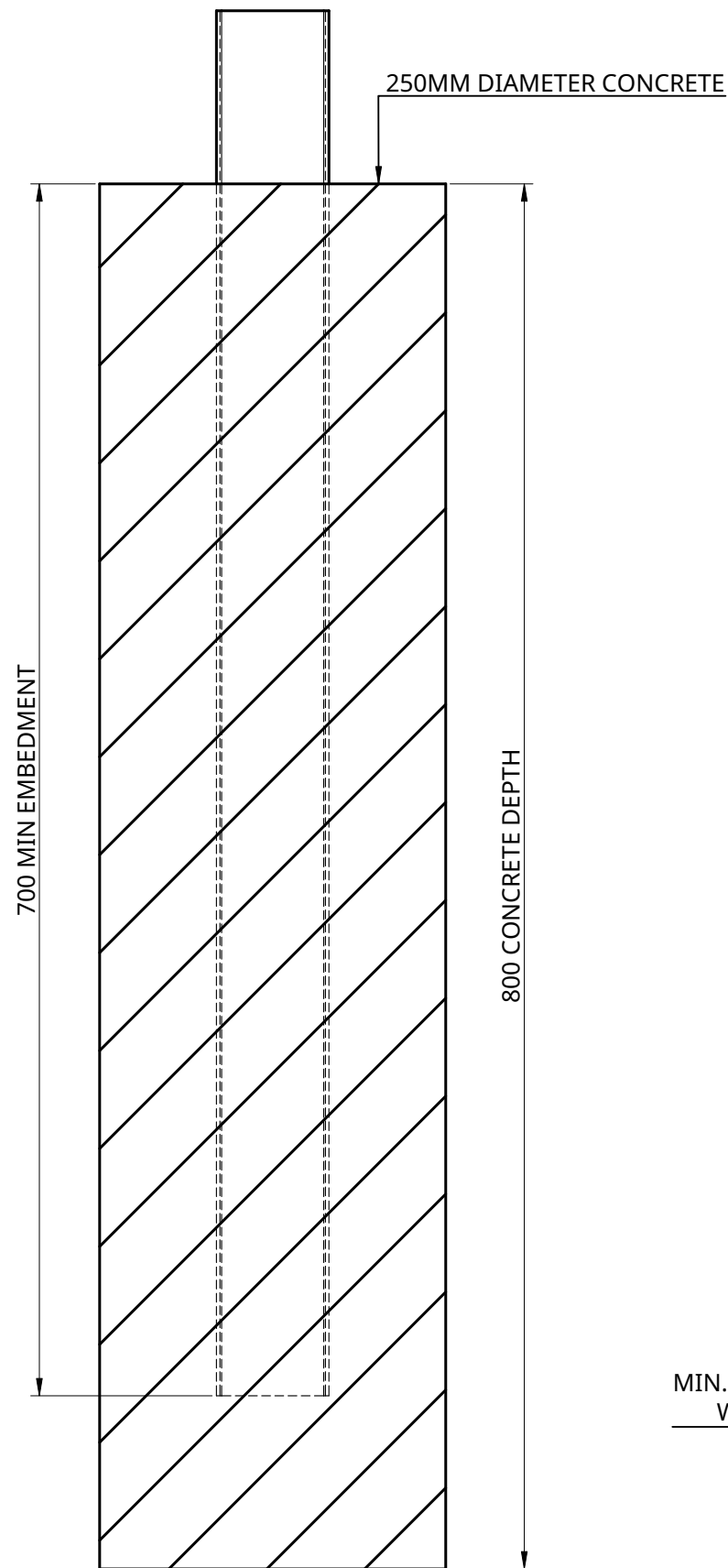

IN GROUND POST CONNECTION

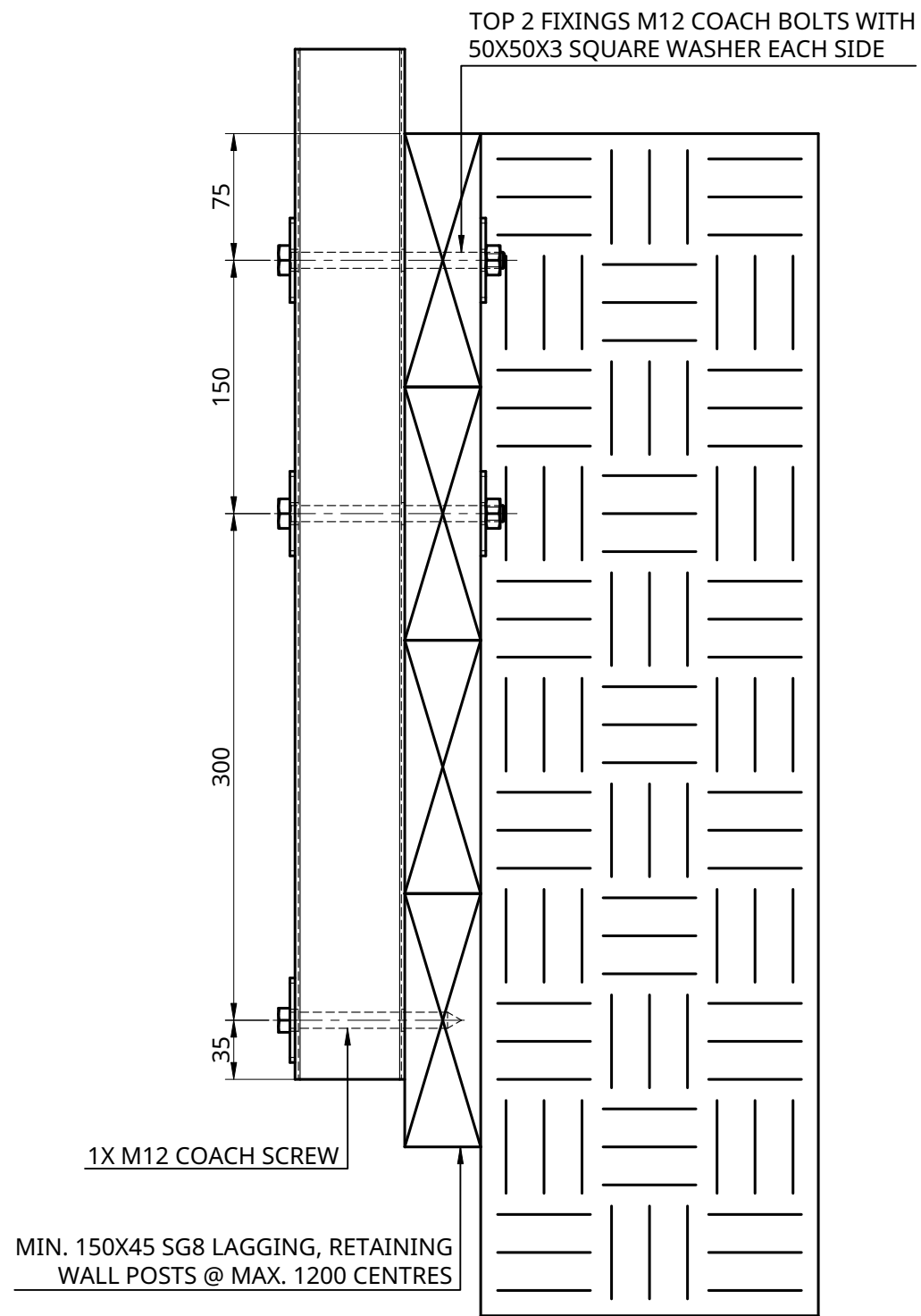

SIDE FIX TO TIMBER RETAINING WALL CONNECTION

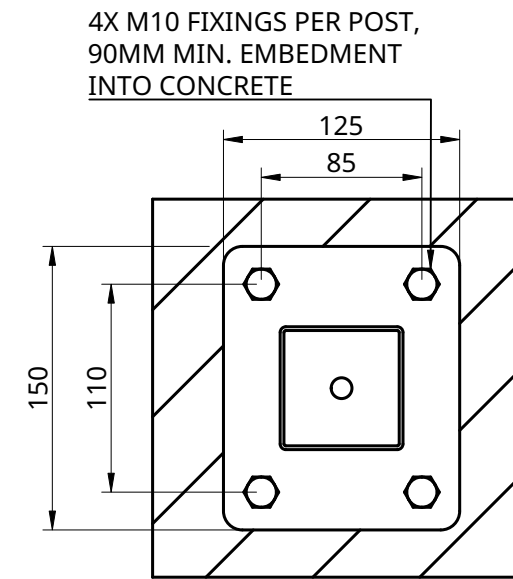

BASEPLATED POST CONNECTION

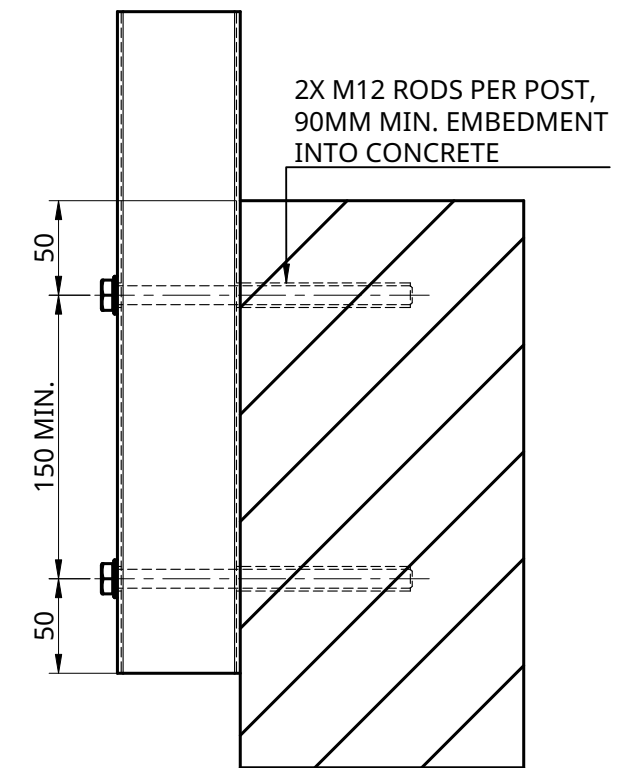

SIDE FIX TO CONCRETE CONNECTION



SIZE:	A3	SCALE:	1:4
DRAWING NO:	PRE10 - SS	REVISION:	01
DATE ISSUED:	2023-02-22	SHEET:	2 OF 2